











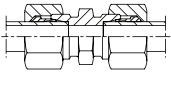
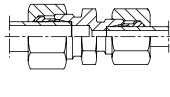
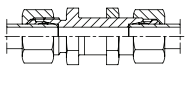
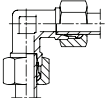
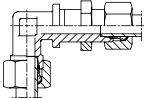
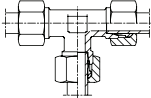
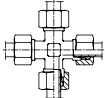
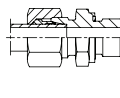
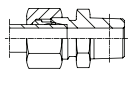



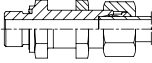
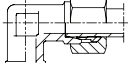
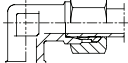
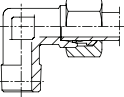
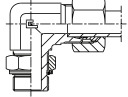
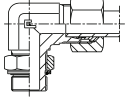

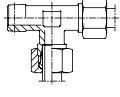
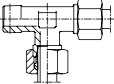
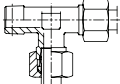
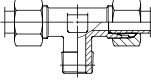
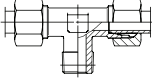
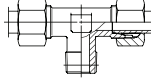
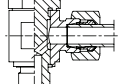
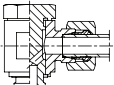
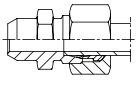
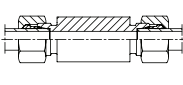
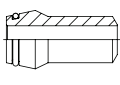
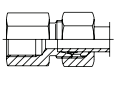
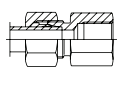
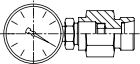
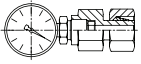

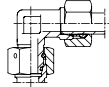
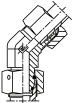
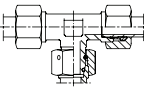
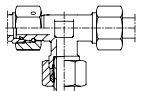

SNIJRINGKOPPELINGEN, LEIDINGBEUGELS EN KOEGELKRANEN

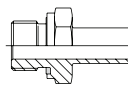
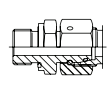
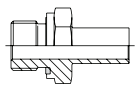
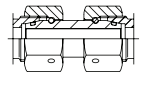
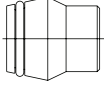
<p>SNIJRING B3</p>  <p>BLZ-170</p>	<p>SNIJRING B4</p>  <p>BLZ-170</p>	<p>MOER</p>  <p>BLZ-171</p>	<p>G</p>  <p>BLZ-171</p>	<p>GR</p>  <p>BLZ-172</p>	<p>SV</p>  <p>BLZ-172</p>
<p>W</p>  <p>BLZ-173</p>	<p>WSV</p>  <p>BLZ-173</p>	<p>T</p>  <p>BLZ-174</p>	<p>K</p>  <p>BLZ-174</p>	<p>GE-LR/SR</p>  <p>BLZ-175</p>	<p>GE-LRK/SRK</p>  <p>BLZ-176</p>
<p>GE-L/S NPT</p>  <p>BLZ-176</p>	<p>GE-LM/SM</p>  <p>BLZ-177</p>	<p>GE-L/S UNF</p>  <p>BLZ-177</p>	<p>SV-LR/SR</p>  <p>BLZ-178</p>	<p>WE-LR/SR</p>  <p>BLZ-178</p>	<p>WE-L/S NPT</p>  <p>BLZ-179</p>
<p>WE-L/S METR</p>  <p>BLZ-179</p>	<p>WEE-LR/SR</p>  <p>BLZ-180</p>	<p>WEE-LM/SM</p>  <p>BLZ-180</p>	<p>WEE-LR45/SR45</p>  <p>BLZ-181</p>	<p>WEE-LM45/SM45</p>  <p>BLZ-181</p>	<p>LE-LR/SR</p>  <p>BLZ-182</p>
<p>LE-L/S NPT</p>  <p>BLZ-182</p>	<p>LE-L/S METR</p>  <p>BLZ-183</p>	<p>TE-LR/SR</p>  <p>BLZ-183</p>	<p>TE-L/S NPT</p>  <p>BLZ-184</p>	<p>LE-L/S METR</p>  <p>BLZ-184</p>	<p>SWV-O-LR/SR</p>  <p>BLZ-185</p>
<p>SWV-O-L/S METR</p>  <p>BLZ-185</p>	<p>GAS</p>  <p>BLZ-186</p>	<p>GES</p>  <p>BLZ-186</p>	<p>SNO</p>  <p>BLZ-187</p>	<p>GAI-LR/SR</p>  <p>BLZ-187</p>	<p>GAI-L/S METR</p>  <p>BLZ-188</p>
<p>MAV</p>  <p>BLZ-188</p>	<p>EMAV</p>  <p>BLZ-188</p>	<p>RL/RS</p>  <p>BLZ-189</p>	<p>KOVO</p>  <p>BLZ-190</p>	<p>VAD</p>  <p>BLZ-191</p>	<p>EW</p>  <p>BLZ-191</p>
<p>EW45</p>  <p>BLZ-191</p>					

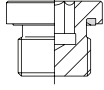
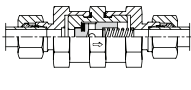
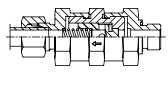
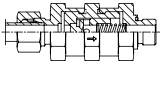
SNIJRINGKOPPELINGEN, LEIDINGBEUGELS EN KOGELKRANEN

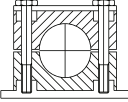
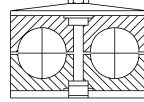
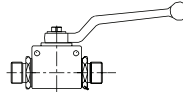
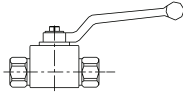
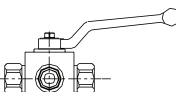
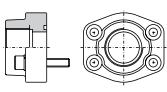
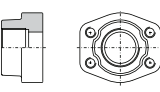
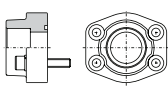
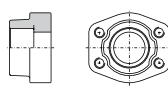
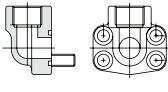
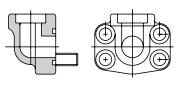
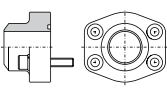
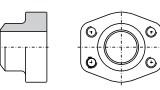
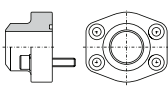
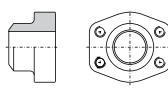
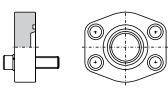
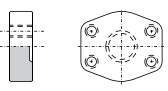
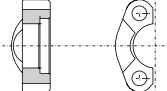
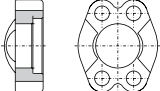
<p>ET</p>  <p>BLZ-192</p>	<p>EL</p>  <p>BLZ-192</p>	<p>PS-LR/SR</p>  <p>BLZ-193</p>	<p>PS-LR/SR</p>  <p>BLZ-193</p>	<p>PS-LM/SM METR</p>  <p>BLZ-194</p>	<p>PS-LM/SM METR</p>  <p>BLZ-194</p>
<p>GVO</p>  <p>BLZ-195</p>	<p>STOP</p>  <p>BLZ-195</p>	<p>VS</p>  <p>BLZ-196</p>	<p>PLUG</p>  <p>BLZ-196</p>	<p>RD</p>  <p>BLZ-196</p>	<p>RV</p>  <p>BLZ-197</p>
<p>RZ</p>  <p>BLZ-197</p>	<p>BORDEL</p>  <p>BLZ-198</p>	<p>SKEP</p>  <p>BLZ-199</p>	<p>SKDP</p>  <p>BLZ-201</p>	<p>BK-LR/SR</p>  <p>BLZ-202</p>	<p>BK</p>  <p>BLZ-203</p>
<p>BK3-LR/SR</p>  <p>BLZ-203</p>	<p>AFS-G</p>  <p>BLZ-205</p>	<p>GFS-G</p>  <p>BLZ-205</p>	<p>AFS-S</p>  <p>BLZ-206</p>	<p>GFS-S</p>  <p>BLZ-206</p>	<p>AFS-G90</p>  <p>BLZ-207</p>
<p>GFS-S90</p>  <p>BLZ-207</p>	<p>AFS-ST</p>  <p>BLZ-208</p>	<p>GFS-ST</p>  <p>BLZ-208</p>	<p>AFS-SRE</p>  <p>BLZ-209</p>	<p>GFS-SRE</p>  <p>BLZ-209</p>	<p>AFC</p>  <p>BLZ-210</p>
<p>GFC</p>  <p>BLZ-210</p>	<p>RX-FC</p>  <p>BLZ-211</p>	<p>RXH-FC</p>  <p>BLZ-211</p>	<p>OR-SFH</p>  <p>BLZ-212</p>		

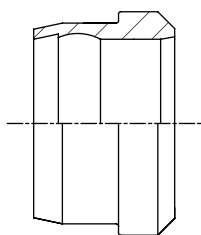
Dubbele snijring B3

Artikelnummer	PN/WD bar	Snijring diam. mm
Snijring 04LL	100	4
Snijring 05LL	100	5
Snijring 06LL	100	6
Snijring 08LL	100	8
Snijring 06L/S	630	6
Snijring 08L/S	630	8
Snijring 10L/S	630	10
Snijring 12L/S	630	12
Snijring 15L	315	15
Snijring 18L	315	18
Snijring 22L	160	22
Snijring 28L	160	28
Snijring 35L	160	35
Snijring 42L	160	42
Snijring 14S	630	14
Snijring 16S	400	16
Snijring 20S	400	20
Snijring 25S	400	25
Snijring 30S	400	30
Snijring 38S	315	38

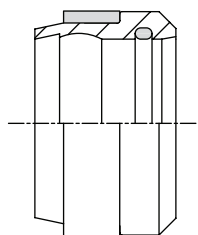
Dubbele snijring met rubber afdichting B4

Artikelnummer	PN/WD	Snijring diam. Diam.mm
Lichte serie		
Snijring 6L B4	315	6
Snijring 8L B4	315	8
Snijring 10L B4	315	10
Snijring 12L B4	315	12
Snijring 15L B4	315	15
Snijring 18L B4	315	18
Snijring 22L B4	160	22
Snijring 28L B4	160	28
Snijring 35L B4	160	35
Snijring 42L B4	160	42
Zware serie		
Snijring 6S B4	630	6
Snijring 8S B4	630	8
Snijring 10S B4	630	10
Snijring 12S B4	630	12
Snijring 14S B4	630	14
Snijring 16S B4	400	16
Snijring 20S B4	400	20
Snijring 25S B4	400	25
Snijring 30S B4	400	30
Snijring 38S B4	315	38

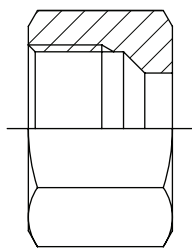
Moer met metrische draad

Artikelnummer	Metrische draad	PN/WD bar	Pijpmaat mm
Lichte serie			
M 04LL	M8×1.0	100	4
M 05LL	M10×1.0	100	5
M 06LL	M10×1.0	100	6
M 08LL	M12×1.0	100	8
M 06L	M12×1.5	315	6
M 08L	M14×1.5	315	8
M 10L	M16×1.5	315	10
M 12L	M18×1.5	315	12
M 15L	M22×1.5	315	15
M 18L	M26×1.5	315	18
M 22L	M30×2.0	160	22
M 28L	M36×2.0	160	28
M 35L	M45×2.0	160	35
M 42L	M52×2.0	160	42
Zware serie			
M 06S	M14×1.5	630	6
M 08S	M16×1.5	630	8
M 10S	M18×1.5	630	10
M 12S	M20×1.5	630	12
M 14S	M22×1.5	630	14
M 16S	M24×1.5	400	16
M 20S	M30×2.0	400	20
M 25S	M36×2.0	400	25
M 30S	M42×2.0	400	30
M 38S	M52×2.0	315	38

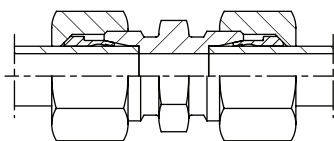
Rechte verbindingskoppeling

Artikelnummer	PN/WD bar	Pijpmaat mm
Lichte serie		
G 04LL	100	4
G 05LL	100	5
G 06LL	100	6
G 08LL	100	8
G 06L	315	6
G 08L	315	8
G 10L	315	10
G 12L	315	12
G 15L	315	15
G 18L	315	18
G 22L	160	22
G 28L	160	28
G 35L	160	35
G 42L	160	42
Zware serie		
G 06S	630	6
G 08S	630	8
G 10S	630	10
G 12S	630	12
G 14S	630	14
G 16S	400	16
G 20S	400	20
G 25S	400	25
G 30S	400	30
G 38S	315	38

Rechte verloopkoppeling

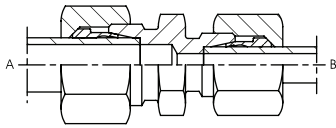

Artikelnummer	PN/WD bar	Pijpmaat A mm	Pijpmaat B mm
Lichte serie			
GR 08/06L	315	8	6
GR 10/06L	315	10	6
GR 10/08L	315	10	8
GR 12/06L	315	12	6
GR 12/08L	315	12	8
GR 12/10L	315	12	10
GR 15/10L	315	15	10
GR 15/12L	315	15	12
GR 18/10L	315	18	10
GR 18/12L	315	18	12
GR 18/15L	315	18	15
GR 22/10L	160	22	10
GR 22/12L	160	22	12
GR 22/15L	160	22	15
GR 22/18L	160	22	18
GR 28/15L	160	28	15
GR 28/18L	160	28	18
GR 28/22L	160	28	22
GR 35/22L	160	35	22
GR 35/28L	160	35	28
Zware serie			
GR 08/06S	630	8	6
GR 10/06S	630	10	6
GR 10/08S	630	10	8
GR 12/06S	630	12	6
GR 12/08S	630	12	8
GR 12/10S	630	12	10
GR 14/10S	630	14	10
GR 14/12S	630	14	12
GR 16/08S	400	16	8
GR 16/12S	400	16	12
GR 16/14S	400	16	14
GR 20/10S	400	20	10
GR 20/12S	400	20	12
GR 20/14S	400	20	14
GR 25/16S	400	25	16
GR 25/20S	400	25	20
GR 30/16S	400	30	16
GR 30/20S	400	30	20
GR 30/25S	400	30	25
GR 38/30S	415	38	30

Rechte schotkoppeling

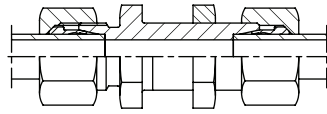

Artikelnummer	PN/WD bar	Pijpmaat mm
Lichte serie		
SV 06L	315	6
SV 08L	315	8
SV 10L	315	10
SV 12L	315	12
SV 15L	315	15
SV 18L	315	18
SV 22L	160	22
SV 28L	160	28
SV 35L	160	35
SV 42L	160	42
Zware serie		
SV 06S	630	6
SV 08S	630	8
SV 10S	630	10
SV 12S	630	12
SV 14S	630	14
SV 16S	400	16
SV 20S	400	20
SV 25S	400	25
SV 30S	400	30
SV 38S	315	38

Haakse verbindingskoppeling

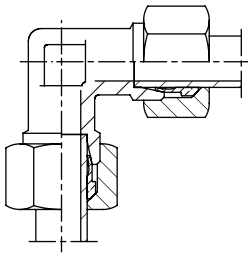

Artikelnummer	PN/WD bar	Pijpmaat mm
Lichte serie		
W 04LL	100	4
W 05LL	100	5
W 06LL	100	6
W 08LL	100	8
W 06L	315	6
W 08L	315	8
W 10L	315	10
W 12L	315	12
W 15L	315	15
W 18L	315	18
W 22L	160	22
W 28L	160	28
W 35L	160	35
W 42L	160	42
Zware serie		
W 06S	630	6
W 08S	630	8
W 10S	630	10
W 12S	630	12
W 14S	630	14
W 16S	400	16
W 20S	400	20
W 25S	400	25
W 30S	400	30
W 38S	315	38

Haakse schotkoppeling

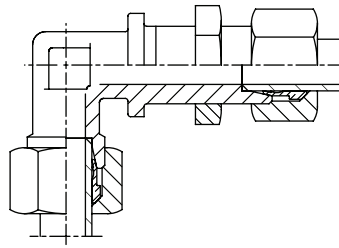

Artikelnummer	PN/WD bar	Pijpmaat mm
Lichte serie		
WSV 06L	315	6
WSV 08L	315	8
WSV 10L	315	10
WSV 12L	315	12
WSV 15L	315	15
WSV 18L	315	18
WSV 22L	160	22
WSV 28L	160	28
WSV 35L	160	35
WSV 42L	160	42
Zware serie		
WSV 06S	400	6
WSV 08S	400	8
WSV 10S	400	10
WSV 12S	400	12
WSV 14S	400	14
WSV 16S	400	16
WSV 20S	400	20
WSV 25S	400	25
WSV 30S	400	30
WSV 38S	315	38

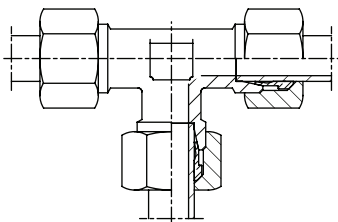
T - verbindingskoppeling

Artikelnummer	PN/WD bar	Pijpmaat mm
Lichte serie		
T 04LL	100	4
T 05LL	100	5
T 06LL	100	6
T 08LL	100	8
T 06L	315	6
T 08L	315	8
T 10L	315	10
T 12L	315	12
T 15L	315	15
T 18L	315	18
T 22L	160	22
T 28L	160	28
T 35L	160	35
T 42L	160	42
Zware serie		
T 06S	630	6
T 08S	630	8
T 10S	630	10
T 12S	630	12
T 14S	630	14
T 16S	400	16
T 20S	400	20
T 25S	400	25
T 30S	400	30
T 38S	315	38

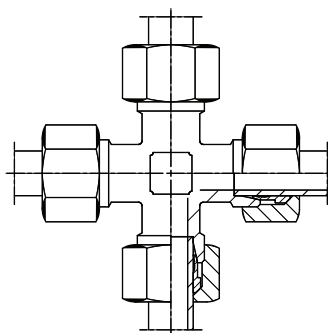
Kruisstuk

Artikelnummer	PN/WD bar	Pijpmaat mm
Lichte serie		
K 06L	315	6
K 08L	315	8
K 10L	315	10
K 12L	315	12
K 15L	315	15
K 18L	315	18
K 22L	160	22
K 28L	160	28
K 35L	160	35
K 42L	160	42
Zware serie		
K 06S	630	6
K 08S	630	8
K 10S	630	10
K 12S	630	12
K 14S	630	14
K 16S	400	16
K 20S	400	20
K 25S	400	25
K 30S	400	30
K 38S	315	38

Rechte inschroefkoppeling met BSP draad en dichtring, lichte serie

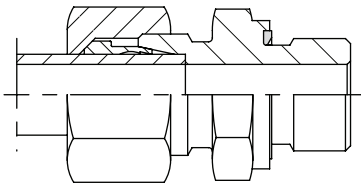

Artikelnummer	PN/WD bar	Pijpmaat mm
Lichte serie		
GE 04LLR 1/8" WD	100	4
GE 06LLR 1/8" WD	100	6
GE 08LLR 1/8" WD	100	8
GE 06LR 1/8" WD	315	6
GE 06LR 1/4" WD	315	6
GE 06LR 3/8" WD	315	6
GE 06LR 1/2" WD	315	6
GE 08LR 1/8" WD	15	8
GE 08LR 1/4" WD	315	8
GE 08LR 3/8" WD	315	8
GE 08LR 1/2" WD	315	8
GE 10LR 1/8" WD	315	10
GE 10LR 1/4" WD	315	10
GE 10LR 3/8" WD	315	10
GE 10LR 1/2" WD	315	10
GE 12LR 1/4" WD	315	12
GE 12LR 3/8" WD	315	12
GE 12LR 1/2" WD	315	12
GE 12LR 3/4" WD	315	12
GE 15LR 3/8" WD	315	15
GE 15LR 1/2" WD	315	15
GE 15LR 3/4" WD	315	15
GE 18LR 3/8" WD	315	18
GE 18LR 1/2" WD	315	18
GE 18LR 3/4" WD	315	18
GE 22LR 1/2" WD	160	22
GE 22LR 3/4" WD	160	22
GE 22LR 1" WD	160	22
GE 28LR 3/4" WD	160	28
GE 28LR 1" WD	160	28
GE 28LR 1-1/4" WD	160	28
GE 35LR 1" WD	160	35
GE 35LR 1-1/4" WD	160	35
GE 42LR 1-1/4" WD	160	42
GE 42LR 1-1/2" WD	160	42

Rechte inschroefkoppeling met BSP draad en dichtring, zware serie

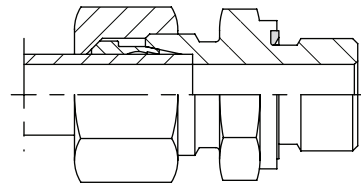

Artikelnummer	PN/WD bar	Pijpmaat mm
Zware serie		
GE 06SR 1/4" WD	630	6
GE 08SR 1/4" WD	630	8
GE 10SR 1/4" WD	630	10
GE 10SR 3/8" WD	630	10
GE 10SR 1/2" WD	630	10
GE 12SR 1/4" WD	630	12
GE 12SR 3/8" WD	630	12
GE 12SR 1/2" WD	630	12
GE 14SR 3/8" WD	630	14
GE 14SR 1/2" WD	630	14
GE 16SR 3/8" WD	400	16
GE 16SR 1/2" WD	400	16
GE 16SR 3/4" WD	400	16
GE 20SR 1/2" WD	400	20
GE 20SR 3/4" WD	400	20
GE 20SR 1" WD	400	20
GE 25SR 3/4" WD	400	25
GE 25SR 1" WD	400	25
GE 25SR 1-1/4" WD	400	25
GE 30SR 3/4" WD	400	30
GE 30SR 1" WD	400	30
GE 30SR 1-1/4" WD	400	30
GE 38SR 1-1/4" WD	315	38
GE 38SR 1-1/2" WD	315	38

Inschroefkoppeling met BSPT draad conisch

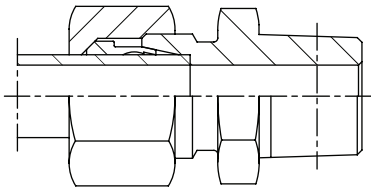

Artikelnummer	PN/WD bar	Pijpmaat mm
Lichte serie		
GE 04LLRK 1/8"	100	4
GE 06LLRK 1/8"	100	6
GE 08LLRK 1/8"	100	8
GE 06LRK 1/8"	315	6
GE 06LRK 1/4"	315	6
GE 08LRK 1/8"	315	8
GE 08LRK 1/4"	315	8
GE 08LRK 3/8"	315	8
GE 08LRK 1/2"	315	8
GE 10LRK 1/8"	315	10
GE 10LRK 1/4"	315	10
GE 10LRK 3/8"	315	10
GE 10LRK 1/2"	315	10
GE 12LRK 1/4"	315	12
GE 12LRK 3/8"	315	12
GE 12LRK 1/2"	315	12
GE 15LRK 3/8"	315	15
GE 15LRK 1/2"	315	15
GE 18LRK 1/2"	315	18
GE 18LRK 3/4"	315	18
GE 22LRK 3/4"	160	22
GE 28LRK 1"	160	28
GE 35LRK 1-1/4"	160	35
GE 42LRK 1-1/2"	160	42
Zware serie		
GE 06SRK 1/4"	630	6
GE 08SRK 1/4"	630	8
GE 10SRK 3/8"	630	10
GE 12SRK 3/8"	630	12
GE 12SRK 1/2"	630	12
GE 14SRK 3/8"	630	14
GE 14SRK 1/2"	630	14
GE 16SRK 3/8"	400	16
GE 16SRK 1/2"	400	16
GE 20SRK 1/2"	400	20
GE 20SRK 3/4"	400	20
GE 25SRK 3/4"	400	25
GE 25SRK 1"	400	25
GE 30SRK 1"	400	30
GE 30SRK 1-1/4"	400	30
GE 38SRK 1-1/2"	315	38

Rechte inschroefkoppeling met NPT draad

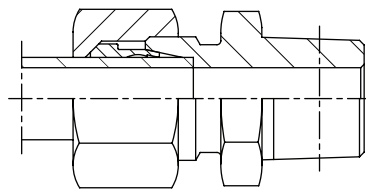

Artikelnummer	PN/WD bar	Pijpmaat mm
Lichte serie		
GE 06L 1/8" NPT	315	6
GE 06L 1/4" NPT	315	6
GE 08L 1/8" NPT	315	8
GE 08L 1/4" NPT	315	8
GE 08L 3/8" NPT	315	8
GE 08L 1/2" NPT	315	8
GE 10L 1/8" NPT	315	10
GE 10L 1/4" NPT	315	10
GE 10L 3/8" NPT	315	10
GE 12L 1/4" NPT	315	12
GE 12L 3/8" NPT	315	12
GE 12L 1/2" NPT	315	12
GE 15L 3/8" NPT	315	15
GE 15L 1/2" NPT	315	15
GE 18L 1/2" NPT	315	18
GE 18L 3/4" NPT	315	18
GE 22L 3/4" NPT	160	22
GE 28L 3/4" NPT	160	28
GE 28L 1" NPT	160	28
GE 35L 1-1/4" NPT	160	35
GE 42L 1-1/2" NPT	160	42
Zware serie		
GE 06S 1/4" NPT	630	6
GE 08S 1/4" NPT	630	8
GE 10S 3/8" NPT	630	10
GE 12S 3/8" NPT	630	12
GE 12S 1/2" NPT	630	12
GE 12S 3/4" NPT	630	12
GE 14S 3/8" NPT	630	14
GE 14S 1/2" NPT	630	14
GE 16S 3/8" NPT	400	16
GE 16S 1/2" NPT	400	16
GE 20S 1/2" NPT	400	20
GE 20S 3/4" NPT	400	20
GE 20S 1" NPT	400	20
GE 25S 3/4" NPT	400	25
GE 25S 1" NPT	400	25
GE 30S 1" NPT	400	30
GE 38S 1-1/4" NPT	315	38
GE 38S 1-1/2" NPT	315	38

Rechte inschroefkoppeling met metrische draad en met dichtring

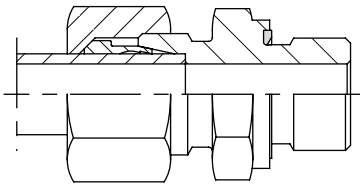

Artikelnummer	PN/WD bar	Pijpmaat mm
Lichte serie		
GE 04LLM 8X1 WD	100	4
GE 06LLM 10X1 WD	100	6
GE 08LLM 10X1 WD	100	8
GE 06LM 10X1 WD	315	6
GE 06LM 12X1,5 WD	315	6
GE 08LM 10X1 WD	315	8
GE 08LM 12X1,5 WD	315	8
GE 08LM 14X1,5 WD	315	8
GE 08 LM 18X1,5 WD	315	8
GE 10LM 14X1,5 WD	315	10
GE 10LM 16X1,5 WD	315	10
GE 10LM 18X1,5 WD	315	10
GE 10LM 22X1,5 WD	315	10
GE 10LM 22X1,5 WD	315	10
GE 12LM 14X1,5 WD	315	12
GE 12LM 16X1,5 WD	315	12
GE 12LM 18X1,5 WD	315	12
GE 12LM 22X1,5 WD	315	12
GE 15LM 16X1,5 WD	315	15
GE 15LM 18X1,5 WD	315	15
GE 15LM 22X1,5 WD	315	15
GE 18LM 18X1,5 WD	315	18
GE 18LM 22X1,5 WD	315	18
GE 22LM 22X1,5 WD	160	22
GE 22LM 26X1,5 WD	160	22
GE 28LM 33X2 WD	160	28
GE 35LM 42X2 WD	160	35
GE 42LM 48X2 WD	160	42
Zware serie		
GE 06SM 12X1,5 WD	630	6
GE 08SM 14X1,5 WD	630	8
GE 12SM 18X1,5 WD	630	12
GE 12SM 22X1,5 WD	630	12
GE 14SM 20X1,5 WD	630	14
GE 16SM 18X1,5 WD	400	16
GE 16SM 22X1,5 WD	400	16
GE 20SM 22X1,5 WD	400	20
GE 20SM 27X2 WD	400	20
GE 25SM 27X2 WD	400	25
GE 30SM 33X2 WD	400	30
GE 30SM 42X2 WD	400	30
GE 38SM 48X2 WD	315	38

Rechte inschroefkoppeling met UNF draad en dichtring

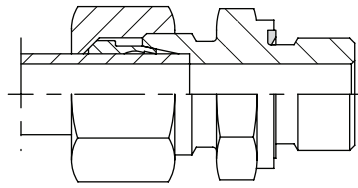

Artikelnummer	PN/WD bar	Pijpmaat mm
Lichte serie		
GE 06L 7/16" UNF	315	6
GE 08L 7/16" UNF	315	8
GE 08L 1/2" UNF	315	8
GE 10L 7/16" UNF	315	10
GE 10L 1/2" UNF	315	10
GE 10L 9/16" UNF	315	10
GE 12L 3/4" UNF	315	12
GE 12L 7/8" UNF	315	12
GE 15L 3/4" UNF	315	15
GE 18L 3/4" UNF	315	18
GE 18L 7/8" UNF	160	18
GE 22L 7/8" UNF	160	22
GE 22L 1-1/16" UNF	160	22
GE 22L 1-5/16" UNF	160	22
GE 28L 1-1/16" UNF	160	28
GE 28L 1-5/16" UNF	160	28
GE 35L 1-5/16" UNF	160	35
GE 35L 1-5/8" UNF	160	35
GE 42L 1-5/8" UNF	160	42
GE 42L 1-7/8" UNF	160	42
Zware serie		
GE 06S 1/2" UNF	630	6
GE 08S 7/16" UNF	630	8
GE 08S 1/2" UNF	630	8
GE 10S 9/16" UNF	630	10
GE 12S 9/16" UNF	630	12
GE 12S 3/4" UNF	630	12
GE 14S 3/4" UNF	630	14
GE 16S 3/4" UNF	400	16
GE 16S 7/8" UNF	400	16
GE 20S 3/4" UNF	400	20
GE 20S 7/8" UNF	400	20
GE 20S 1-1/16" UNF	400	20
GE 25S 1-1/16" UNF	400	25
GE 25S 1-5/16" UNF	400	25
GE 30S 1-5/16" UNF	400	30
GE 30S 1-5/8" UNF	400	30
GE 38S 1-5/8" UNF	315	38
GE 38S 1-7/8" UNF	315	38

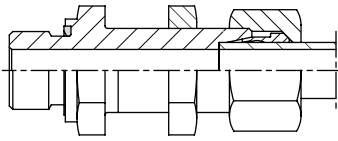
Speciale landbouw schotkoppeling met BSP draad

Artikelnummer	PN/WD bar	Pijpmaat mm
Lichte serie		
SV 06LR 1/8" WD	315	6
SV 08LR 1/4" WD	315	8
SV 10LR 1/4" WD	315	10
SV 12LR 3/8" WD	315	12
SV 12LR 1/2"	315	12
SV 15LR 1/2" WD	315	15
SV 18LR 1/2" WD	315	18
SV 22LR 3/4" WD	160	22
SV 28LR 1" WD	160	28
SV 35LR 1-1/4" WD	160	35
SV 42LR 1-1/2" WD	160	42
Zware serie		
SV 06SR 1/4" WD	630	6
SV 08SR 1/4" WD	630	8
SV 10SR 3/8" WD	630	10
SV 12SR 3/8" WD	630	12
SV 14SR 1/2" WD	630	14
SV 16SR 1/2" WD	400	16
SV 20SR 3/4" WD	400	20
SV 25SR 1" WD	400	25
SV 30SR 1-1/4" WD	400	30
SV 38SR 1-1/2" WD	315	38

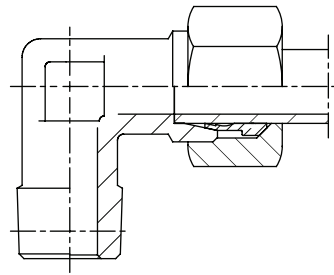
Haakse inschroeffkoppeling met BSP draad Conisch

Artikelnummer	PN/WD bar	Pijpmaat mm
Lichte serie		
WE 04LLR 1/8" K	100	4
WE 06LLR 1/8" K	100	6
WE 08 LLR 1/8" K	100	8
WE 06LR 1/8" K	315	6
WE 06LR 1/4" K	315	6
WE 08LR 1/8" K	315	8
WE 08LR 1/4" K	315	8
WE 08LR 3/8" K	315	8
WE 08LR 1/2" K	315	8
WE 10LR 1/8" K	315	10
WE 10LR 1/4" K	315	10
WE 10LR 3/8" K	315	10
WE 10LR 1/2" K	315	10
WE 12LR 1/4" K	315	12
WE 12LR 3/8" K	315	12
WE 12LR 1/2" K	315	12
WE 15LR 3/8" K	315	15
WE 15LR 1/2" K	315	15
WE 18LR 1/2" K	315	18
WE 18LR 3/4" K	315	18
WE 22LR 3/4" K	160	22
WE 28LR 1" K	160	28
WE 35LR 1-1/4" K	160	35
Zware serie		
WE 06SR 1/4" K	630	6
WE 08SR 1/4" K	630	8
WE 10SR 3/8" K	630	10
WE 12SR 3/8" K	630	12
WE 12SR 1/2" K	630	12
WE 14SR 3/8" K	630	14
WE 14SR 1/2" K	630	14
WE 16SR 3/8" K	400	16
WE 16SR 1/2" K	400	16
WE 20SR 1/2" K	400	20
WE 20SR 3/4" K	400	20
WE 25SR 3/4" K	400	25
WE 25SR 1" K	400	25
WE 30SR 1" K	400	30
WE 30SR 1-1/4" K	400	30
WE 38SR 1-1/2" K	315	38

**Haakse inschroefkoppeling met NPT draad
Conisch**

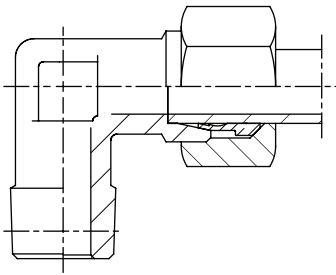

Artikelnummer	PN/WD bar	Pijpmaat mm
Lichte serie		
WE 06L 1/8" NPT	315	6
WE 06L 1/4" NPT	315	6
WE 08L 1/8" NPT	315	8
WE 08L 1/4" NPT	315	8
WE 08L 3/8" NPT	315	8
WE 08L 1/2" NPT	315	8
WE 10L 1/8" NPT	315	10
WE 10L 1/4" NPT	315	10
WE 10L 3/8" NPT	315	10
WE 10L 1/2" NPT	315	10
WE 12L 1/4" NPT	315	12
WE 12L 3/8" NPT	315	12
WE 12L 1/2" NPT	315	12
WE 15L 3/8" NPT	315	15
WE 15L 1/2" NPT	315	15
WE 18L 3/8" NPT	315	18
WE 18L 1/2" NPT	315	18
WE 22L 3/4" NPT	160	22
WE 28L 1" NPT	160	28
WE 35L 1-1/4" NPT	160	35
WE 42L 1-1/2" NPT	160	42
Zware serie		
WE 06S 1/4" NPT	630	6
WE 08S 1/4" NPT	630	8
WE 10S 3/8" NPT	630	10
WE 12S 3/8" NPT	630	12
WE 12S 1/2" NPT	630	12
WE 14S 3/8" NPT	630	14
WE 14S 1/2" NPT	630	14
WE 16S 3/8" NPT	400	16
WE 16S 1/2" NPT	400	16
WE 20S 1/2" NPT	400	20
WE 20S 3/4" NPT	400	20
WE 25S 3/4" NPT	400	25
WE 25S 1" NPT	400	25
WE 30S 1" NPT	400	30
WE 30S 1-1/4" NPT	400	30
WE 38S 1-1/2" NPT	315	38

**Haakse inschroefkoppeling met metrische draad
Conisch**

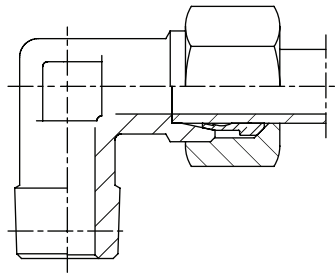

Artikelnummer	PN/WD bar	Pijpmaat mm
Lichte serie		
WE 06LM 10x1.0	315	6
WE 08LM 12X1.5	315	8
WE 10LM 14X1.5	315	10
WE 12LM 16X1.5	315	12
WE 15LM 18X1.5	315	15
WE 18LM 22X1.5	315	18
Zware serie		
WE 06SM 12X1.5	400	6
WE 08SM 14X1.5	400	8
WE 10SM 16X1.5	400	10
WE 12SM 18X1.5	400	12
WE 14SM 20X1.5	400	14
WE 16SM 22X1.5	400	16

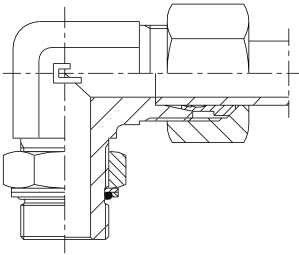
Haakse instelbare inschroefkoppeling met BSP draad met o-ring en borgmoer

Artikelnummer	Metrische draad	PN/WD bar	Pijpmaat mm
Lichte serie			
WEE 6LR 1/8	M12×1.5	315	6
WEE 8LR 1/4	M14×1.5	315	8
WEE 10LR 1/4	M16×1.5	315	10
WEE 12LR 3/8	M18×1.5	315	12
WEE 15LR 1/2	M22×1.5	315	15
WEE 18LR 1/2	M26×1.5	315	18
WEE 22LR 3/4	M30×2.0	160	22
WEE 28LR 1	M36×2.0	160	28
WEE 35LR 1-1/4	M45×2.0	160	35
WEE 42LR 1-1/2	M52×2.0	160	42
Zware serie			
WEE 6SR 1/4	M14×1.5	630	6
WEE 8SR 1/4	M16×1.5	630	8
WEE 10SR 3/8	M18×1.5	630	10
WEE 12SR 3/8	M20×1.5	630	12
WEE 14SR 1/2	M22×1.5	630	14
WEE 16SR 1/2	M24×1.5	400	16
WEE 20SR 3/4	M30×1.5	400	20
WEE 25SR 1	M36×2.0	400	25
WEE 30SR 1-1/4	M42×2.0	400	30
WEE 38SR 1-1/2	M52×2.0	315	38

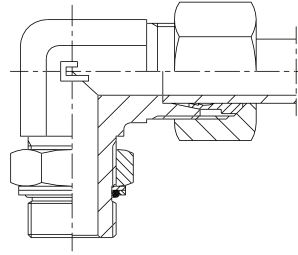
Haakse instelbare inschroefkoppeling met metrische draad met o-ring en borgmoer

Artikelnummer	Metrische draad	PN/WD bar	Pijpmaat mm
Lichte serie			
WEE 6LM 10x1	M12×1.5	315	6
WEE 8LM 12x1,5	M14×1.5	315	8
WEE 10LM 14x1,5	M16×1.5	315	10
WEE 12LM 16x1,5	M18×1.5	315	12
WEE 15LM 18x1,5	M22×1.5	315	15
WEE 18LM 22x1,5	M26×1.5	315	18
WEE 22LM 27x2	M30×2.0	160	22
WEE 28LM 33x2	M36×2.0	160	28
WEE 35LM 42x2	M45×2.0	160	35
WEE 42LM 48x2	M52×2.0	160	42
Zware serie			
WEE 6SM 12x1,5	M14×1.5	630	6
WEE 8SM 14x1,5	M16×1.5	630	8
WEE 10SM 16x1,5	M18×1.5	630	10
WEE 12SM 18x1,5	M20×1.5	630	12
WEE 14SM 20x1,5	M22×1.5	630	14
WEE 16SM 22x1,5	M24×1.5	400	16
WEE 20SM 28x2	M30×1.5	400	20
WEE 25SM 33x2	M36×2.0	400	25
WEE 30SM 42x2	M42×2.0	400	30
WEE 38SM 48x2	M52×2.0	315	38

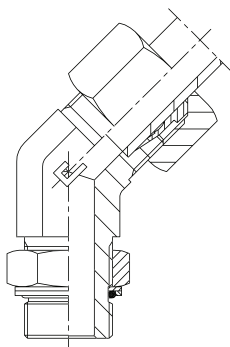
45 instelbare inschroefkoppeling met BSP draad met o-ring en borgmoer

Artikelnummer	Metrische draad	PN/WD bar	Pijpmaat mm
Lichte serie			
WEE 6LR 1/8 45"	M12×1.5	315	6
WEE 8LR 1/4 45"	M14×1.5	315	8
WEE 10LR 1/4 45"	M16×1.5	315	10
WEE 12LR 3/8 45"	M18×1.5	315	12
WEE 15LR 1/2 45"	M22×1.5	315	15
WEE 18LR 1/2 45"	M26×1.5	315	18
WEE 22LR 3/4 45"	M30×2.0	160	22
WEE 28LR 1 45"	M36×2.0	160	28
WEE 35LR 1-1/4 45"	M45×2.0	160	35
WEE 42LR 1-1/2 45"	M52×2.0	160	42
Zware serie			
WEE 6SR 1/4 45"	M14×1.5	630	6
WEE 8SR 1/4 45"	M16×1.5	630	8
WEE 10SR 3/8 45"	M18×1.5	630	10
WEE 12SR 3/8 45"	M20×1.5	630	12
WEE 14SR 1/2 45"	M22×1.5	630	14
WEE 16SR 1/2 45"	M24×1.5	400	16
WEE 20SR 3/4 45"	M30×1.5	400	20
WEE 25SR 1 45"	M36×2.0	400	25
WEE 30SR 1-1/4 45"	M42×2.0	400	30
WEE 38SR 1-1/2 45"	M52×2.0	315	38

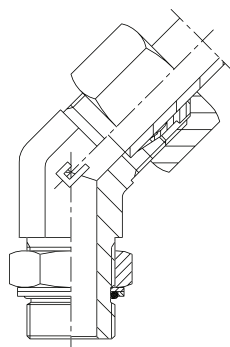
45 instelbare inschroefkoppeling met metrische draad met o-ring en borgmoer

Artikelnummer	Metrische draad	PN/WD bar	Pijpmaat mm
Lichte serie			
WEE 6LM 10x1 45"	M12×1.5	315	6
WEE 8LM 12x1,5 45"	M14×1.5	315	8
WEE 10LM 14x1,5 45"	M16×1.5	315	10
WEE 12LM 16x1,5 45"	M18×1.5	315	12
WEE 15LM 18x1,5 45"	M22×1.5	315	15
WEE 18LM 22x1,5 45"	M26×1.5	315	18
WEE 22LM 27x2 45"	M30×2.0	160	22
WEE 28LM 33x2 45"	M36×2.0	160	28
WEE 35LM 42x2 45"	M45×2.0	160	35
WEE 42LM 48x2 45"	M52×2.0	160	42
Zware serie			
WEE 6SM 12x1,5 45"	M14×1.5	630	6
WEE 8SM 14x1,5 45"	M16×1.5	630	8
WEE 10SM 16x1,5 45"	M18×1.5	630	10
WEE 12SM 18x1,5 45"	M20×1.5	630	12
WEE 14SM 20x1,5 45"	M22×1.5	630	14
WEE 16SM 22x1,5 45"	M24×1.5	400	16
WEE 20SM 27x2 45"	M30×1.5	400	20
WEE 25SM 33x2 45"	M36×2.0	400	25
WEE 30SM 42x2 45"	M42×2.0	400	30
WEE 38SM 48x2 45"	M52×2.0	315	38

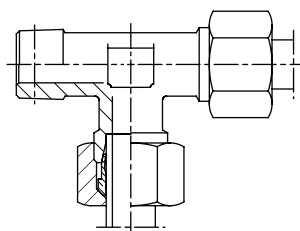
**L-inschroefkoppeling met BSP draad
Conisch**

Artikelnummer	PN/WD bar	Pijpmaat mm
Lichte serie		
LE 04LLR 1/8"	100	4
LE 08LLR 1/8"	100	8
LE 06LR 1/8"	315	6
LE 08LR 1/4"	315	8
LE 10LR 1/4"	315	10
LE 12LR 3/8"	315	12
LE 15LR 1/2"	315	15
LE 18LR 1/2"	315	18
LE 22LR 3/4"	160	22
LE 28LR 1"	160	28
LE 35LR 1.1/4"	160	35
LE 42LR 1.1/2"	160	42
Zware serie		
LE 06SR 1/4"	630	6
LE 08SR 1/4"	630	8
LE 10SR 3/8"	630	10
LE 12SR 3/8"	630	12
LE 14SR 1/2"	630	14
LE 16SR 1/2"	400	16
LE 20SR 3/4"	400	20
LE 25SR 1"	400	25
LE 30SR 1.1/4"	400	30
LE 38SR 1.1/2"	315	38

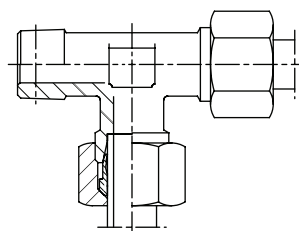
L-inschroefkoppeling met NPT draad

Artikelnummer	PN/WD bar	Pijpmaat mm
Lichte serie		
LE 06L 1/8" NPT	315	6
LE 08L 1/4" NPT	315	8
LE 10L 1/4" NPT	315	10
LE 12L 3/8" NPT	315	12
LE 15L 1/2" NPT	315	15
LE 18L 1/2" NPT	315	18
LE 22L 3/8" NPT	160	22
LE 28L 1" NPT	160	28
LE 35L 1-1/4" NPT	160	35
LE 42L 1-1/2" NPT	160	42
Zware serie		
LE 06S 1/4" NPT	630	6
LE 08S 1/4" NPT	630	8
LE 10S 3/8" NPR	630	10
LE 12S 3/8" NPT	630	12
LE 14S 1/2" NPT	630	14
LE 16S 1/2" NPT	400	16
LE 20S 3/4" NPT	400	20
LE 25S 1" NPT	400	25
LE 30S 1-1/4" NPT	400	30
LE 38S 1-1/2" NPT	315	38

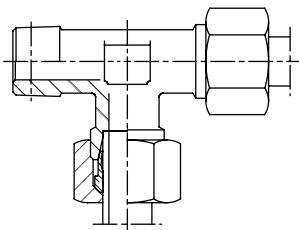
**L-inschroefkoppeling met metrische draad
Conisch**

Artikelnummer	PN/WD bar	Pijpmaat mm
Lichte serie		
LE 06LM 10X1	315	6
LE 08LM 12X1.5	315	8
LE 10LM 14X1.5	315	10
LE 12LM 16X1.5	315	12
LE 15LM 18X1.5	315	15
LE 18LM 22X1.5	315	18
LE 22LM 26X1.5	160	22
LE 28LM 33X2.0	160	28
LE 35LM 42X2.0	160	35
LE 42LM 48X2.0	160	42
Zware serie		
LE 06SM 12X1.5	630	6
LE 08SM 14X1.5	630	8
LE 10SM 16X1.5	630	10
LE 12SM 18X1.5	630	12
LE 14SM 20X1.5	630	14
LE 16SM 22X1.5	400	16
LE 20SM 27X2.0	400	20
LE 25SM 33X2.0	400	25
LE 30SM 42X2.0	400	30
LE 38SM 48X2.0	315	38

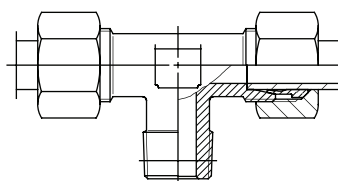
**T-inschroefkoppeling met BSP draad
Conisch**

Artikelnummer	PN/WD bar	Pijpmaat mm
Lichte serie		
TE 04LLR1/8"	100	4
TE 06LLR1/8"	100	6
TE 08LLR1/8"	100	8
TE 06LR1/8"	315	6
TE 08LR1/4"	315	8
TE 10LR1/4"	315	10
TE 12LR3/8"	315	12
TE 15LR1/2"	315	15
TE 18LR1/2"	315	18
TE 22LR3/4"	160	22
TE 28LR1"	160	28
TE 35LR1.1/4"	160	35
TE 42LR1.1/2"	160	42
Zware serie		
TE 06SR1/4"	400	6
TE 08SR1/4"	400	8
TE 10SR3/8"	400	10
TE 12SR3/8"	400	12
TE 14SR1/2"	400	14
TE 16SR1/2"	400	16
TE 20SR3/4"	400	20
TE 25SR1"	400	25
TE 30SR1.1/4"	250	30
TE 38SR1.1/2"	250	38

**T-inschroefkoppeling met NPT draad
Conisch**

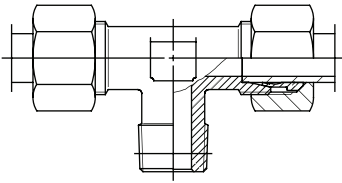

Artikelnummer	PN/WD bar	Pijpmaat mm
Lichte serie		
TE 06L 1/8" NPT	315	6
TE 08L 1/4" NPT	315	8
TE 10L 1/4" NPT	315	10
TE 12L 3/8" NPT	315	12
TE 15L 1/2" NPT	315	15
TE 18L 1/2" NPT	315	18
TE 22L 3/4" NPT	160	22
TE 28L 1" NPT	160	28
TE 35L 1.1/4" NPT	160	35
TE 42L 1.1/2" NPT	160	42
Zware serie		
TE 06S 1/4" NPT	400	6
TE 08S 1/4" NPT	400	8
TE 10S 3/8" NPT	400	10
TE 12S 3/8" NPT	400	12
TE 14S 1/2" NPT	400	14
TE 16S 1/2" NPT	400	16
TE 20S 3/4" NPT	400	20
TE 25S 1" NPT	400	25
TE 30S 1.1/4" NPT	250	30
TE 38S 1.1/2" NPT	250	38

**T-inschroefkoppeling met metrische draad
Conisch**

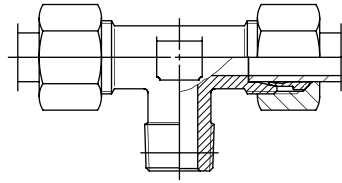

Artikelnummer	PN/WD bar	Pijpmaat mm
Lichte serie		
TE 8LLM10X1.0	100	8
TE 06LM10X1.0	315	6
TE 08LM12X1.5	315	8
TE 10LM14X1.5	315	10
TE 12LM16X1.5	315	12
TE 15LM18X1.5	315	15
TE 18LM22X1.5	315	18
TE 22LM26X1.5	160	22
TE 28LM33X2.0	160	28
TE 35LM42X2.0	160	35
TE 42LM48X2.0	160	42
Zware serie		
TE 06SM12X1.5	630	6
TE 08SM14X1.5	630	8
TE 10SM16X1.5	630	10
TE 12SM18X1.5	630	12
TE 14SM20X1.5	630	14
TE 16SM22X1.5	400	16
TE 20SM27X2.0	400	20
TE 25SM33X2.0	400	25
TE 30SM42X2.0	250	30
TE 38SM48X2.0	250	38

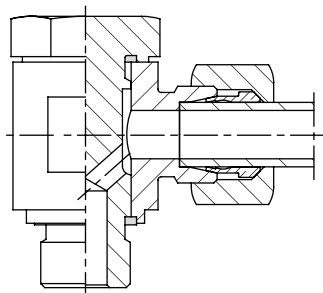
Banjokkoppeling met BSP draad en met O-ring

Artikelnummer	PN/WD bar	Pijpmaat mm
Lichte serie		
SWV-O 4LLR 1/8"	100	4
SWV-O 6LLR 1/8"	100	6
SWV-O 8LLR 1/4"	315	8
SWV-O 06LR 1/8"	315	6
SWV-O 08LR 1/4"	315	8
SWV-O 10LR 1/4"	315	10
SWV-O 12LR 3/8"	315	12
SWV-O 15LR 1/2"	315	15
SWV-O 18LR 1/2"	315	18
SWV-O 22LR 3/4"	160	22
SWV-O 28LR 1"	160	28
SWV-O 35LR 1.1/4"	160	35
SWV-O 42LR 1.1/2"	160	42
Zware serie		
SWV-O 06SR 1/4"	400	6
SWV-O 08SR 1/4"	400	8
SWV-O 10SR 3/8"	400	10
SWV-O 12SR 3/8"	400	12
SWV-O 14SR 1/2"	315	14
SWV-O 16SR 1/2"	315	16
SWV-O 20SR 3/4"	250	20
SWV-O 25SR 1"	250	25
SWV-O 30SR 1.1/4"	250	30
SWV-O 38SR 1.1/2"	200	38

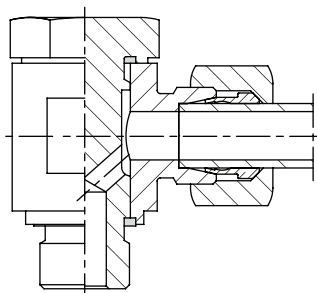
Banjokoppeling met metrische draad en O-ring

Artikelnummer	PN/WD bar	Pijpmaat mm
Lichte serie		
SWV-O 04LLM8X1.0	100	6
SWV-O 06LLM10X1.0	100	6
SWV-O 08LLM10X1.0	100	8
SWV-O 06LM10X1.0	315	6
SWV-O 08LM12X1.5	315	8
SWV-O 10LM14X1.5	315	10
SWV-O 12LM16X1.5	315	12
SWV-O 15LM18X1.5	315	15
SWV-O 18LM22X1.5	315	18
SWV-O 22LM26X1.5	160	22
SWV-O 28LM33X2.0	160	28
SWV-O 35LM42X2.0	160	35
Zware serie		
SWV 06SM12X1.5	400	6
SWV 08SM14X1.5	400	8
SWV 10SM16X1.5	400	10
SWV 12SM18X1.5	400	12
SWV 14SM20X1.5	315	14
SWV 16SM22X1.5	315	16
SWV 20SM27X2.0	250	20

Laskoppeling

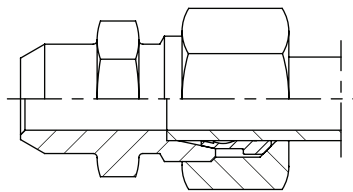

Artikelnummer	PN/WD bar	Pijpmaat mm
Lichte serie		
GAS 06L	315	6
GAS 08L	315	8
GAS 10L	315	10
GAS 12L	315	12
GAS 15L	315	15
GAS 18L	315	18
GAS 22L	160	22
GAS 28L	160	28
GAS 35L	160	35
GAS 42L	160	42
Zware serie		
GAS 06S	630	6
GAS 08S	630	8
GAS 10S	630	10
GAS 12S	630	12
GAS 14S	630	14
GAS 16S	400	16
GAS 20S	400	20
GAS 25S	400	25
GAS 30S	400	30
GAS 38S	315	38

Lasshot koppeling

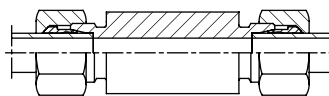

Artikelnummer	PN/WD bar	Pijpmaat mm
Lichte serie		
GES 06L	315	6
GES 08L	315	8
GES 10L	315	10
GES 12L	315	12
GES 15L	315	15
GES 18L	315	18
GES 22L	160	22
GES 28L	160	28
GES 35L	160	35
GES 42L	160	42
Zware serie		
GES 06S	630	6
GES 08S	630	8
GES 10S	630	10
GES 12S	630	12
GES 14S	630	14
GES 16S	400	16
GES 20S	400	20
GES 25S	400	25
GES 30S	400	30
GES 38S	315	38

Lasnippel met O-ring

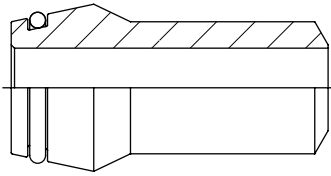

Artikelnummer	Pijpmaat mm
SNO 6X1,5	6
SNO 8X2	8
SNO 10X2	10
SNO 12X1,5	12
SNO 12X2	12
SNO 12X2,5	12
SNO 14X3	14
SNO 15X2,5	15
SNO 16X2	16
SNO 16X2,5	16
SNO 16X3	16
SNO 18X2,5	18
SNO 20X2,5	20
SNO 20X3	20
SNO 20X4	20
SNO 22X2,5	22
SNO 25X3	25
SNO 25X4	25
SNO 28X2,5	28
SNO 30X3	30
SNO 30 X5	30
SNO 30X6	30
SNO 35X3	35
SNO 38X3	38
SNO 38X5	38
SNO 38X6	38
SNO 38X8	38
SNO 42X3	42

Rechte opschroefkoppeling met BSP draad

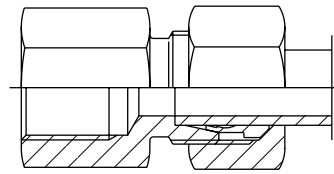

Artikelnummer	PN/WD bar	Pijpmaat mm
Lichte serie		
GAI 06LR 1/8"	315	6
GAI 08LR 1/4"	315	8
GAI 08LR 3/8"	315	8
GAI 08LR 1/2"	315	8
GAI 10LR 1/4"	315	10
GAI 10LR 3/8"	315	10
GAI 12LR 1/4"	315	12
GAI 12LR 3/8"	315	12
GAI 12LR 1/2"	315	12
GAI 15LR 1/2"	315	15
GAI 15LR 3/8"	315	15
GAI 18LR 3/8"	315	18
GAI 18LR 1/2"	315	18
GAI 22LR 3/4"	160	22
GAI 28LR 1"	160	28
GAI 35LR 1.1/4"	160	35
GAI 42LR 1.1/2"	160	42
Zware serie		
GAI 06SR 1/4"	30	6
GAI 08SR 1/4"	630	8
GAI 10SR 3/8"	630	10
GAI 12SR 3/8"	630	12
GAI 12SR 1/2"	630	12
GAI 14SR 1/2"	630	14
GAI 16SR 1/2"	400	16
GAI 20SR 3/4"	400	20
GAI 25SR 1"	400	25
GAI 30SR 1.1/4"	400	30
GAI 38SR 1.1/2"	315	38

Rechte opschroefkoppeling met metrische draad

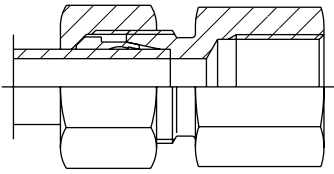

Artikelnummer	PN/WD bar	Pijpmaat mm
Lichte serie		
GAI 06LM 10X1.0	315	6
GAI 08LM 12X1.5	315	8
GAI 10LM 14X1.5	315	10
GAI 12LM 16X1.5	315	12
GAI 15LM 18X1.5	315	15
GAI 18LM 22X1.5	315	18
GAI 22LM 26X1.5	160	22
GAI 28LM 33X2	160	28
GAI 35LM 42X2	160	35
GAI 42LM 48X2	160	42

Artikelnummer	PN/WD bar	Pijpmaat mm
Zware serie		
GAI 06SM 12X1.5	630	6
GAI 08SM 14X1.5	630	8
GAI 10SM 16X1.5	630	10
GAI 12SM 18X1.5	630	12
GAI 14SM 20X1.5	630	14
GAI 16SM 22X1.5	400	16
GAI 20SM 27X2.0	400	20
GAI 25SM 33X2.0	400	25
GAI 30SM 42X2.0	400	30
GAI 38SM 48X2.0	315	38

Manometer koppeling met BSP binnendraad

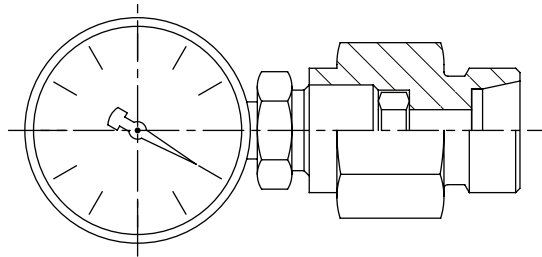

Artikelnummer	PN/WD bar	Pijpmaat mm
Lichte serie		
MAV 06LR 1/4"	315	6
MAV 08LR 1/4"	315	8
MAV 10LR 1/4"	315	10
MAV 12LR 1/4"	315	12
Zware serie		
MAV 06SR 1/2"	630	6
MAV 08SR 1/2"	630	8
MAV 10SR 1/2"	630	10
MAV 12SR 1/2"	630	12

Instelbare manometerkoppeling

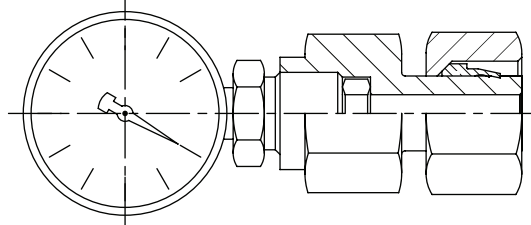

Artikelnummer	PN/WD bar	Pijpmaat mm
Lichte serie		
EMAV 06LR 1/4"	315	6
EMAV 08LR 1/4"	315	8
EMAV 10LR 1/4"	315	10
EMAV 12LR 1/4"	315	12
Zware serie		
EMAV 06SR 1/2"	630	6
EMAV 08SR 1/2"	630	8
EMAV 10SR 1/2"	630	10
EMAV 12SR 1/2"	630	12

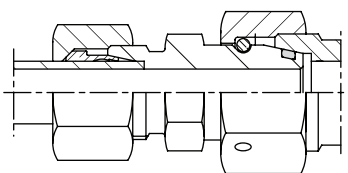
Verloopkoppeling, DKO uitvoering

Artikelnummer	PN/WD bar	Pijpmaat mm	Pijpmaat mm
Lichte serie			
RL 08/06 DKO	315	8	6
RL 10/06 DKO	315	10	6
RL 10/08 DKO	315	10	8
RL 12/06 DKO	315	12	6
RL 12/08 DKO	315	12	8
RL 12/10 DKO	315	12	10
RL 15/06 DKO	315	15	6
RL 15/08 DKO	315	15	8
RL 15/10 DKO	315	15	10
RL 15/12 DKO	315	15	12
RL 18/06 DKO	315	18	6
RL 18/08 DKO	315	18	8
RL 18/10 DKO	315	18	10
RL 18/12 DKO	315	18	12
RL 18/15 DKO	315	18	15
RL 22/06 DKO	160	22	6
RL 22/08 DKO	160	22	8
RL 22/10 DKO	160	22	10
RL 22/12 DKO	160	22	12
RL 22/15 DKO	160	22	15
RL 22/18 DKO	160	22	18
RL 28/06 DKO	160	28	6
RL 28/08 DKO	160	28	8
RL 28/10 DKO	160	28	10
RL 28/12 DKO	160	28	12
RL 28/15 DKO	160	28	15
RL 28/18 DKO	160	28	18
RL 28/22 DKO	160	28	22
RL 35/06 DKO	160	35	6
RL 35/08 DKO	160	35	8
RL 35/10 DKO	160	35	10
RL 35/12 DKO	160	35	12
RL 35/15 DKO	160	35	15
RL 35/18 DKO	160	35	18
RL 35/22 DKO	160	35	22
RL 35/28 DKO	160	35	28
RL 42/06 DKO	160	42	6
RL 42/08 DKO	160	42	8
RL 42/10 DKO	160	42	10
RL 42/12 DKO	160	42	12
RL 42/15 DKO	160	42	15
RL 42/18 DKO	160	42	18
RL 42/22 DKO	160	42	22
RL 42/28 DKO	160	42	28
RL 42/35 DKO	160	42	35

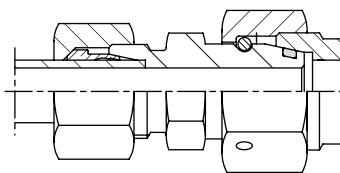
Verloopkoppeling, DKO uitvoering

Artikelnummer	PN/WD bar	Pijpmaat mm	Pijpmaat mm
Zware serie			
RS 08/06 DKO	630	8	6
RS 10/06 DKO	630	10	6
RS 10/08 DKO	630	10	8
RS 12/06 DKO	630	12	6
RS 12/08 DKO	630	12	8
RS 12/10 DKO	630	12	10
RS 14/06 DKO	630	14	6
RS 14/08 DKO	630	14	8
RS 14/10 DKO	630	14	10
RS 14/12 DKO	630	14	12
RS 16/06 DKO	400	16	6
RS 16/08 DKO	400	16	8
RS 16/10 DKO	400	16	10
RS 16/12 DKO	400	16	12
RS 16/14 DKO	400	16	14
RS 20/06 DKO	400	20	6
RS 20/08 DKO	400	20	8
RS 20/10 DKO	400	20	10
RS 20/12 DKO	400	20	12
RS 20/14 DKO	400	20	14
RS 20/16 DKO	400	20	16
RS 25/06 DKO	400	25	6
RS 25/08 DKO	400	25	8
RS 25/10 DKO	400	25	10
RS 25/12 DKO	400	25	12
RS 25/14 DKO	400	25	14
RS 25/16 DKO	400	25	16
RS 25/20 DKO	400	25	20
RS 30/06 DKO	400	30	6
RS 30/08 DKO	400	30	8
RS 30/10 DKO	400	30	10
RS 30/12 DKO	400	30	12
RS 30/14 DKO	400	30	14
RS 30/16 DKO	400	30	16
RS 30/20 DKO	400	30	20
RS 30/25 DKO	400	30	25
RS 38/06 DKO	315	38	6
RS 38/08 DKO	315	38	8
RS 38/10 DKO	315	38	10
RS 38/12 DKO	315	38	12
RS 38/16 DKO	315	38	16
RS 38/20 DKO	315	38	20
RS 38/25 DKO	315	38	25
RS 38/30 DKO	315	38	30

Verloop koppeling, DKO uitvoering

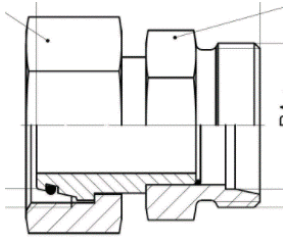

Artikelnummer	DKO A	opname B	PN/WD bar
KOVO 6L/8L	L6	L8	315
KOVO 6L/10L	L6	L10	315
KOVO 6L/12L	L6	L12	315
KOVO 6L/6S	L6	S6	315
KOVO 6L/8S	L6	S8	315
KOVO 6L/10S	L6	S10	315
KOVO 6S/6L	S6	L6	315
KOVO 6S/6S	S6	S6	600
KOVO 6S/8S	S6	S8	400
KOVO 6S/10S	S6	S10	400
KOVO 8L BO	L8	L8	315
KOVO 8L/10L	L8	L10	315
KOVO 8L/12L	L8	L12	315
KOVO 8L/8S	L8	S8	315
KOVO 8L/10S	L8	S10	315
KOVO 8L/12S	L8	S12	315
KOVO 8S/8L	S8	L8	315
KOVO 8S/8S	S8	S8	600
KOVO 8S/10S	S8	S10	400
KOVO 8S/12S	S8	S12	400
KOVO 10L	L10	L10	315
KOVO 10L/12L	L10	L12	315
KOVO 10L/15L	L10	L15	315
KOVO 10L/10S	L10	S10	315
KOVO 10L/12S	L10	S12	315
KOVO 10L/14S	L10	S14	315
KOVO 10L/16S	L10	S16	315
KOVO 10S/10L	S10	L10	315
KOVO 10S/10S	S10	S10	600
KOVO 10S/12S	S10	S12	400
KOVO 10S/14S	S10	S14	400
KOVO 10S/16S	S10	S16	400
KOVO 12L	L12	L12	315
KOVO 12L/15L	L12	L15	315
KOVO 12L/18L	L12	L18	315
KOVO 12L/12S	L12	S12	315
KOVO 12L/14S	L12	S14	315
KOVO 12L/16S	L12	S16	315
KOVO 12S/12L	S12	L12	315
KOVO 12S/12S	S12	S12	400
KOVO 12S/14S	S12	S14	400
KOVO 12S/16S	S12	S16	400
KOVO 12S/20S	S12	S20	400
KOVO 14S/15L	S14	L15	315
KOVO 14S/18L	S14	L18	315
KOVO 14S/14S	S14	S14	600

KOVO 14S/16S	S14	S16	400
KOVO 14S/20S	S14	S20	400
KOVO 15L BO	L15	L15	315
KOVO 15L/18L	L15	L18	315
KOVO 15L/22L	L15	L22	315
KOVO 15L/16S	L15	S16	315
KOVO 15L/20S	L15	S20	315
KOVO 16S/18L	S16	L18	315
KOVO 16S/22L	S16	L22	315
KOVO 16S	S16	S16	400
KOVO 16S/20S	S16	S20	400
KOVO 16S/25S	S16	S25	400
KOVO 18L	L18	L18	315
KOVO 18L/22L	L18	L22	160
KOVO 18L/28L	L18	L28	160
KOVO 18L/20S	L18	S20	315
KOVO 18L/25S	L18	S25	315
KOVO 20S/22L	S20	L22	160
KOVO 20S/28L	S20	L28	160
KOVO 20S/20S	S20	S20	400
KOVO 20S/25S	S20	S25	400
KOVO 20S/30S	S20	S30	400
KOVO 22L/22L	L22	L22	160
KOVO 22L/28L	L22	L28	160
KOVO 22L/35L	L22	L35	160
KOVO 22L/25S	L22	S25	160
KOVO 22L/30S	L22	S30	160
KOVO 25S/28L	S25	L28	160
KOVO 25S/35L	S25	L35	160
KOVO 25S/25S	S25	S25	400
KOVO 25S/30S	S25	S30	400
KOVO 25S/38S	S25	S38	330
KOVO 28L/28L	L28	L28	160
KOVO 28L/35L	L28	L35	160
KOVO 28L/42L	L28	L42	160
KOVO 28L/30S	L28	S30	160
KOVO 28L/38S	L28	S38	160
KOVO 30S/35L	S30	L35	160
KOVO 30S/42L	S30	L42	160
KOVO 30S/30S	S30	S30	400
KOVO 30S/38S	S30	S38	360
KOVO 35L/35L	L35	L35	160
KOVO 35L/42L	L35	L42	160
KOVO 35L/38S	L35	S38	160
KOVO 38S/42L	S38	L42	160
KOVO 38S/38S	S38	S38	360
KOVO 42L/42L	L42	L42	160

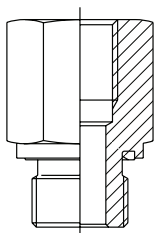
Draadverloopstuk met BSP draad

Artikelnummer	BSP draad	BSP draad	PN/WD bar
VAD 1/8" X1/4"	1/8"	1/4"	630
VAD 1/8" X3/8"	1/8"	3/8"	630
VAD 1/4" X1/8"	1/4"	1/8"	630
VAD 1/4" X3/8"	1/4"	3/8"	630
VAD 1/4" X1/2"	1/4"	1/2"	630
VAD 1/4" X3/4"	1/4"	3/4"	400
VAD 3/8" X1/4"	3/8"	1/4"	630
VAD 3/8" X1/2"	3/8"	1/2"	630
VAD 3/8" X3/4"	3/8"	3/4"	400
VAD 1/2" X3/8"	1/2"	3/8"	400
VAD 1/2" X3/4"	1/2"	3/4"	400
VAD 1/2" X1"	1/2"	1"	400
VAD 1/2" X1.1/4"	1/2"	1.1/4"	250
VAD 3/4" X1/2"	3/4"	1/2"	400
VAD 3/4" X1"	3/4"	1"	400
VAD 3/4" X1.1/4"	3/4"	1.1/4"	250
VAD 3/4" X1.1/2"	3/4"	1.1/2"	250
VAD 1" X3/4"	1"	3/4"	400
VAD 1" X1.1/4"	1"	1.1/4"	250
VAD 1" X1.1/2"	1"	1.1/2"	250
VAD 1.1/4" X1"	1.1/4"	1"	250
VAD 1.1/4" X1.1/2"	1.1/4"	1.1/2"	250
VAD 1.1/2" X1.1/4"	1.1/2"	1.1/4"	250

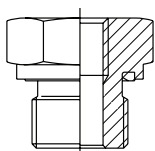
Draadverloopstuk met BSP draad

Artikelnummer	BSP draad	BSP draad	PN/WD bar
VAD 3/8" X1/8"	3/8"	1/8"	630
VAD 1/2" X1/8"	1/2"	1/8"	400
VAD 1/2" X1/4"	1/2"	1/4"	400
VAD 3/4" X1/4"	3/4"	1/4"	400
VAD 3/4" X3/8"	3/4"	3/8"	400
VAD 1" X1/4"	1"	1/4"	400
VAD 1" X3/8"	1"	3/8"	400
VAD 1" X1/2"	1"	1/2"	400
VAD 1.1/4" X1/2"	1.1/4"	1/2"	250
VAD 1.1/4" X3/4"	1.1/4"	3/4"	250
VAD 1.1/2" X1/2"	1.1/2"	1/2"	250
VAD 1.1/2" X3/4"	1.1/2"	3/4"	250
VAD 1.1/2" X1"	1.1/2"	1"	250

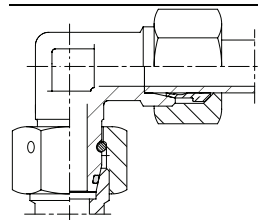
Instelbare knie koppeling, DKO uitvoering

Artikelnummer	Metrische draad	PN/WD bar	Pijpmaat mm
Lichte serie			
EW 06L DKO	M12×1.5	315	6
EW 08L DKO	M14×1.5	315	8
EW 10L DKO	M16×1.5	315	10
EW 12L DKO	M18×1.5	315	12
EW 15L DKO	M22×1.5	315	15
EW 18L DKO	M26×1.5	315	18
EW 22L DKO	M30×2.0	160	22
EW 28L DKO	M36×2.0	160	28
EW 35L DKO	M45×2.0	160	35
EW 42L DKO	M52×2.0	160	42
Zware serie			
EW 06S DKO	M14×1.5	630	6
EW 08S DKO	M16×1.5	630	8
EW 10S DKO	M18×1.5	630	10
EW 12S DKO	M20×1.5	630	12
EW 14S DKO	M22×1.5	630	14
EW 16S DKO	M24×1.5	400	16
EW 20S DKO	M30×2.0	400	20
EW 25S DKO	M36×2.0	400	25
EW 30S DKO	M42×2.0	400	30
EW 38S DKO	M52×2.0	315	38

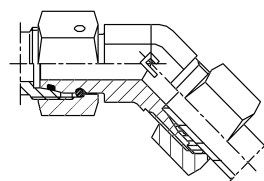
Instelbare 45° knie koppeling, DKO uitvoering

Artikelnummer	Metrische draad	PN/WD bar	Pijpmaat mm
Lichte serie			
EW 6L 45	M12×1.5	315	6
EW 8L 45	M14×1.5	315	8
EW 10L 45	M16×1.5	315	10
EW 12L 45	M18×1.5	315	12
EW 15L 45	M22×1.5	315	15
EW 18L 45	M26×1.5	315	18
EW 22L 45	M30×2.0	160	22
EW 28L 45	M36×2.0	160	28
EW 35L 45	M45×2.0	160	35
EW 42L 45	M52×2.0	160	42
Zware serie			
EW 6S 45	M14×1.5	630	6
EW 8S 45	M16×1.5	630	8
EW 10S 45	M18×1.5	630	10
EW 12S 45	M20×1.5	630	12
EW 14S 45	M22×1.5	630	14
EW 16S 45	M24×1.5	400	16
EW 20S 45	M30×1.5	400	20
EW 25S 45	M36×2.0	400	25
EW 30S 45	M42×2.0	400	30
EW 38S 45	M52×2.0	315	38

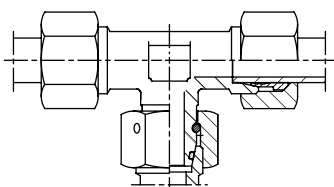
Instelbare T-koppeling, DKO uitvoering

Artikelnummer	Metrische draad	PN/WD bar	Pijpmaat mm
Lichte serie			
ET 06L DKO	M12×1.5	315	6
ET 08L DKO	M14×1.5	315	8
ET 10L DKO	M16×1.5	315	10
ET 12L DKO	M18×1.5	315	12
ET 15L DKO	M22×1.5	315	15
ET 18L DKO	M26×1.5	315	18
ET 22L DKO	M30×2.0	160	22
ET 28L DKO	M36×2.0	160	28
ET 35L DKO	M45×2.0	160	35
ET 42L DKO	M52×2.0	160	42
Zware serie			
ET 06S DKO	M14×1.5	630	6
ET 08S DKO	M16×1.5	630	8
ET 10S DKO	M18×1.5	630	10
ET 12S DKO	M20×1.5	630	12
ET 14S DKO	M22×1.5	630	14
ET 16S DKO	M24×1.5	400	16
ET 20S DKO	M30×2.0	400	20
ET 25S DKO	M36×2.0	400	25
ET 30S DKO	M42×2.0	400	30
ET 38S DKO	M52×2.0	315	38

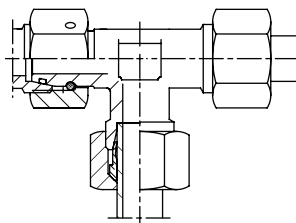
Instelbare L-koppeling, DKO uitvoering

Artikelnummer	Metrische draad	PN/WD bar	Pijpmaat mm
Lichte serie			
EL 06L DKO	M12×1.5	315	6
EL 08L DKO	M14×1.5	315	8
EL 10L DKO	M16×1.5	315	10
EL 12L DKO	M18×1.5	315	12
EL 15L DKO	M22×1.5	315	15
EL 18L DKO	M26×1.5	315	18
EL 22L DKO	M30×2.0	160	22
EL 28L DKO	M36×2.0	160	28
EL 35L DKO	M45×2.0	160	35
EL 42L DKO	M52×2.0	160	42
Zware serie			
EL 06S DKO	M14×1.5	630	6
EL 08S DKO	M16×1.5	630	8
EL 10S DKO	M18×1.5	630	10
EL 12S DKO	M20×1.5	630	12
EL 14S DKO	M22×1.5	630	14
EL 16S DKO	M24×1.5	400	16
EL 20S DKO	M30×2.0	400	20
EL 25S DKO	M36×2.0	400	25
EL 30S DKO	M42×2.0	400	30

Pijpstuk met BSP draad, DKO uitvoering en dichtring

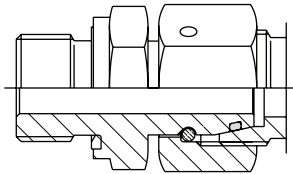

Artikelnummer	PN/WD bar	Pijpmaat mm
Lichte serie		
PS 6LR 1/8" WD DKO	315	6
PS 6LR 1/4" WD DKO	315	6
PS 8LR 1/4" WD DKO	315	8
PS 10LR 3/8" WD DKO	315	10
PS 10LR 1/4" WD DKO	315	10
PS 12LR 1/4" WD DKO	315	12
PS 12LR 3/8" WD DKO	315	12
PS 12LR 1/2" WD DKO	315	12
PS 15LR 1/2" WD DKO	315	15
PS 15LR 3/4 WD DKO	315	15
PS 18LR 1/2" WD DKO	315	18
PS 18LR 3/4 WD DKO	315	18
PS 22LR 3/4 WD DKO	160	22
PS 28LR 3/4 WD DKO	160	28
PS 28LR 1" WD DKO	160	28
PS 35LR 1" WD DKO	160	35
PS 35LR 1.1/4" WD DKO	160	35
PS 35LR 1.1/2" WD DKO	160	35
PS 42LR 1.1/2" WD DKO	160	42
Zware serie		
PS 6SR 1/8" WD DKO	630	6
PS 6SR 1/4" WD DKO	630	6
PS 8SR 3/8" WD DKO	630	8
PS 8SR 1/4" WD DKO	630	8
PS 10SR 1/4" WD DKO*	630	10
PS 10SR 3/8" WD DKO	630	10
PS 10SR 1/2" WD DKO	630	10
PS 12SR 1/4" WD DKO*	630	12
PS 12SR 3/8" WD DKO	630	12
PS 12SR 1/2" WD DKO	630	12
PS 14SR 1/2" WD DKO	630	14
PS 14SR 3/8" WD DKO	630	14
PS 16SR 3/8" WD DKO	400	16
PS 16SR 1/2" WD DKO	400	16
PS 16SR 3/4 WD DKO	400	16
PS 20SR 1/2" WD DKO	400	20
PS 20SR 3/4 WD DKO	400	20
PS 20SR 1" WD DKO	400	20
PS 25SR 1/2" WD DKO	400	25
PS 25SR 1" WD DKO	400	25
PS 25SR 1-1/4" WD DKO	400	25
PS 30SR 1" WD DKO	400	30

PS 30SR 1-1/4" WD DKO	400	30
PS 30SR 1-1/2" WD DKO	400	30
PS 38SR 1-1/4" WD DKO	315	38
PS 38SR 1-1/2" WD DKO	315	38

Pijpstuk met BSP draad, niet voorgemonteerd met dichtring

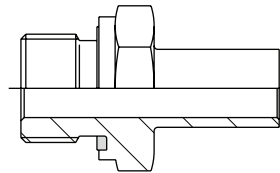

Artikelnummer	PN/WD bar	Pijpmaat mm
Lichte serie		
PS 06LR 1/8"	315	6
PS 08LR 1/4"	315	8
PS 10LR 1/4"	315	10
PS 12LR 1/4"	315	12
PS 12LR 3/8"	315	12
PS 15LR 3/8"	315	15
PS 15LR 1/2"	315	15
PS 18LR 1/2"	315	18
PS 22LR 3/4"	160	22
PS 28LR 1"	160	28
PS 35LR 1.1/4"	160	35
PS 42LR 1.1/2"	160	42
Zware serie		
PS 06SR 1/4"	630	6
PS 08SR 1/4"	630	8
PS 10SR 3/8"	630	10
PS 12SR 3/8"	630	12
PS 12SR 1/2"	630	12
PS 14SR 1/2"	630	14
PS 16SR 1/2"	400	16
PS 20SR 3/4"	400	20
PS 25SR 1"	400	25
PS 30SR 1.1/4"	400	30
PS 38SR 1.1/2"	315	38

Pijpstuk met metrische draad, DKO uitvoering en dichtring

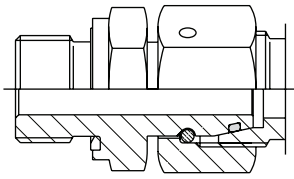

Artikelnummer	PN/WD bar	Pijpmaat mm
Lichte serie		
PS 06LM10X1.0 WD DKO	315	6
PS 08LM12X1.5 WD DKO	315	8
PS 10LM14X1.5 WD DKO	315	10
PS 12LM16X1.5 WD DKO	315	12
PS 15LM18X1.5 WD DKO	315	15
PS 18LM22X1.5 WD DKO	315	18
PS 22LM26X1.5 WD DKO	160	22
PS 28LM33X2.0 WD DKO	160	28
PS 35LM42X2.0 WD DKO	160	35
PS 42LM48X2.0 WD DKO	160	42

Zware serie		
PS 06SM12X1.5 WD DKO	630	6
PS 08SM14X1.5 WD DKO	630	8
PS 10SM16X1.5 WD DKO	630	10
PS 12SM18X1.5 WD DKO	630	12
PS 14SM20X1.5 WD DKO	630	14
PS 16SM22X1.5 WD DKO	400	16
PS 20SM27X2.0 WD DKO	400	20
PS 25SM33X2.0 WD DKO	400	25
PS 30SM42X2.0 WD DKO	400	30
PS 38SM48X2.0 WD DKO	315	38

Pijpstuk met metrische draad, niet voorgemonteerd

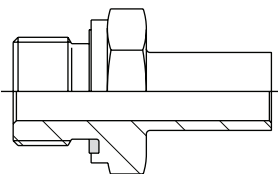

Artikelnummer	PN/WD bar	Pijpmaat mm
Lichte serie		
PS 06LM 10X1.0	315	6
PS 08LM 12X1.5	315	8
PS 10LM 14X1.5	315	10
PS 12LM 16X1.5	315	12
PS 15LM 18X1.5	315	15
PS 18LM 22X1.5	315	18
PS 22LM 26X1.5	160	22

PS 28LM 33X2.0	160	28
PS 35LM 42X2.0	160	35
PS 42LM 48X2.0	160	42

Zware serie		
PS 06SM 12X1.5	630	6
PS 08SM 14X1.5	630	8
PS 10SM 16X1.5	630	10
PS 12SM 18X1.5	630	12
PS 14SM 20X1.5	630	14
PS 16SM 22X1.5	400	16
PS 20SM 27X2.0	400	20
PS 25SM 33X2.0	400	25
PS 30SM 42X2.0	400	30
PS 38SM 48X2.0	315	38

Dubbel pijpstuk, DKO uitvoering

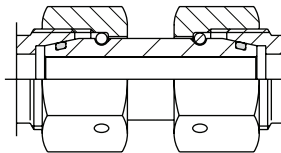

Artikelnummer	PN/WD bar	Pijpmaat mm
Lichte serie		
GVO 06L DKO	315	6
GVO 08L DKO	315	8
GVO 10L DKO	315	10
GVO 12L DKO	315	12
GVO 15L DKO	315	15
GVO 18L DKO	315	18
GVO 22L DKO	160	22
GVO 28L DKO	160	28
GVO 35L DKO	160	35
GVO 42L DKO	160	42

Zware serie		
GVO 06S DKO	630	6
GVO 08S DKO	630	8
GVO 10S DKO	630	10
GVO 12S DKO	630	12
GVO 14S DKO	630	14
GVO 16S DKO	400	16
GVO 20S DKO	400	20
GVO 25S DKO	400	25
GVO 30S DKO	400	30
GVO 38S DKO	315	38

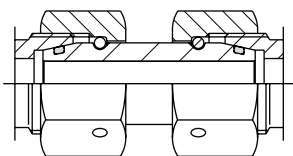
Dubbel pijpstuk verlopend, DKO uitvoering

Artikelnummer	Pijpmaat		PN/WD bar
	A	B	
GVO 6L/8L	L6	L8	315
GVO 6L/10L	L6	L10	315
GVO 6L/6S	L6	S6	315
GVO 6L/8S	L6	S8	315
GVO 6L/10S	L6	S10	315
GVO 6S/8S	S6	S8	400
GVO 6S/10S	S6	S10	400
GVO 8L/8L	L8	L8	315
GVO 8L/10L	L8	L10	315
GVO 8L/12L	L8	L12	315
GVO 8L/8S	L8	S8	315
GVO 8L/10S	L8	S10	315
GVO 8L/12S	L8	S12	315
GVO 8S/10S	S8	S10	400
GVO 8S/12S	S8	S12	400
GVO 10L/12L	L10	L12	315
GVO 10L/15L	L10	L15	315
GVO 10L/10S	L10	S10	315
GVO 10L/12S	L10	S12	315
GVO 10L/14S	L10	S14	315
GVO 10L/16S	L10	S16	315
GVO 10S/12L	S10	L12	315
GVO 10S/15L	S10	L15	315
GVO 10S/12S	S10	S12	400
GVO 10S/14S	S10	S14	400
GVO 12L/15L	L12	L15	315
GVO 12L/18L	L12	L18	315
GVO 12L/12S	L12	S12	315
GVO 12L/14S	L12	S14	315
GVO 12L/16S	L12	S16	315
GVO 12L/20S	L12	S20	315
GVO 12S/15L	S12	L15	315
GVO 12S/14S	S12	S14	400
GVO 12S/16S	S12	S16	400
GVO 14S/15L	S14	L15	315
GVO 14S/18L	S14	L18	315
GVO 14S/16S	S14	S16	400
GVO 14S/20S	S14	S20	400
GVO 15L/18L	L15	L18	315
GVO 15L/22L	L15	L22	315
GVO 15L/16S	L15	S16	315
GVO 15L/20S	L15	S20	315
GVO 15L/25S	L15	S25	315
GVO 16S/18L	S16	L18	315
GVO 16S/22L	S16	L 22	315
GVO 16S/20S	S16	S20	400
GVO 16S/25S	S16	S25	400
GVO 18L/22L	L18	L22	160

GVO 18L/28L	L18	L28	160
GVO 18L/20S	L18	S20	315
GVO 18L/25S	L18	S25	315
GVO 18L/30S	L18	S30	315
GVO 20S/22L	S20	L22	160
GVO 20S/28L	S20	L28	160
GVO 20S/25S	S20	S25	400
GVO 20S/30S	S20	S30	400
GVO 22L/28L	L22	L28	160
GVO 22L/35L	L22	L35	160
GVO 22L/25S	L22	S25	160
GVO 22L/30S	L22	S30	160
GVO 22L/38S	L22	S38	160
GVO 25S/28L	S25	L28	160
GVO 25S/35L	S25	L35	160
GVO 25S/30S	S25	S30	400
GVO 25S/38S	S25	S38	330
GVO 28L/35L	L28	L35	160
GVO 28L/42L	L28	L42	160
GVO 28L/30S	L28	S30	jkj
GVO 28L/38S	L28	S38	160
GVO 30S/35L	S30	L35	160
GVO 30S/42L	S30	L42	160
GVO 30S/38S	S30	S38	360
GVO 35L/42L	L35	L42	160
GVO 35L/38S	L35	S38	160
GVO 38S/42L	S38	L42	160

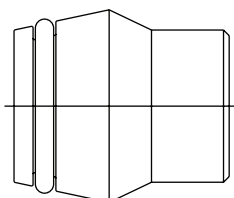
Blind stop

Artikelnummer	PN/WD bar	Pijpmaat mm
Lichte serie		
STOP 06L/S	630	6
STOP 08L/S	630	8
STOP 10L/S	630	10
STOP 12L/S	630	12
STOP 15L	315	15
STOP 18L	315	18
STOP 22L	160	22
STOP 28L	160	28
STOP 35L	160	35
STOP 42L	160	42
Zware serie		
STOP 14S	630	14
STOP 16S	400	16
STOP 20S	400	20
STOP 25S	400	25
STOP 30S	400	30
STOP 38S	315	38

Afblind stop

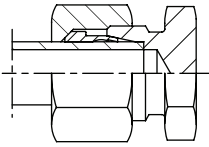

Artikelnummer	PN/WD bar	Pijpmaat mm
Lichte serie		
VS 06L	315	6
VS 08L	315	8
VS 10L	315	10
VS 12L	315	12
VS 15L	315	15
VS 18L	315	18
VS 22L	160	22
VS 28L	160	28
VS 35L	160	35
VS 42L	160	42
Zware serie		
VS 06S	630	6
VS 08S	630	8
VS 10S	630	10
VS 12S	630	12
VS 14S	630	14
VS 16S	400	16
VS 20S	400	20
VS 25S	400	25
VS 30S	400	30
VS 38S	315	38

Draadplug met BSP draad en dichtring

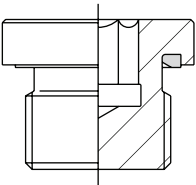

Artikelnummer	PN/WD bar
Plug 1/8" /WD	400
Plug 1/4" /WD	400
Plug 3/8" /WD	400
Plug 1/2" /WD	400
Plug 3/4" /WD	400
Plug 1" /WD	400
Plug 1.1/4" /WD	250
Plug 1.1/2" /WD	250

Draadplug met metrische draad en dichtring

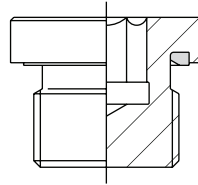

Artikelnummer	PN/WD bar
Plug M 10x1/WD	400
Plug M 12x1.5/WD	400
Plug M 14x1.5/WD	400
Plug M 16x1.5/WD	400
Plug M 18x1.5/WD	400
Plug M 20x1.5/WD	400
Plug M 22x1.5/WD	400
Plug M 24x1.5/WD	400
Plug M 26x1.5/WD	400
Plug M 27x2/WD	400
Plug M 33x2/WD	400
Plug M 42x2/WD	250
Plug M 48x2/WD	250

Terugslagklep

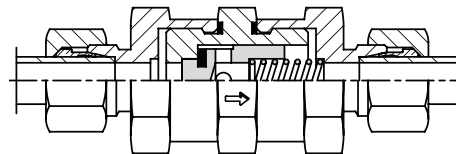

Artikelnummer	PN/WD bar	Pijpmaat mm
Lichte serie		
RD 06L	250	6
RD 08L	250	8
RD 10L	250	10
RD 12L	250	12
RD 15L	250	15
RD 18L	160	18
RD 22L	160	22
RD 28L	160	28
RD 35L	160	35
Zware serie		
RD 06S	400	6
RD 08S	400	8
RD 10S	400	10
RD 12S	400	12
RD 14S	400	14
RD 16S	400	16
RD 20S	400	20
RD 25S	250	25
RD 30S	250	30
RD 38S	250	38

Terugslagklep met BSP draad en met dichtring

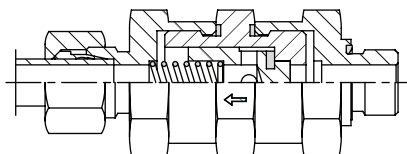

Artikelnummer	PN/WD bar	Pijpmaat mm
Lichte serie		
RV 06LR1/8" WD	250	6
RV 08LR1/4" WD	250	8
RV 10LR1/4" WD	250	10
RV 12LR3/8" WD	250	12
RV 15LR1/2" WD	250	15
RV 18LR1/2" WD	160	18
RV 22LR3/4" WD	160	22
RV 28LR1" WD	100	28
RV35LR1 1/4"WD	100	35
Zware serie		
RV 06SR1/4"WD	400	6
RV 08SR1/4"WD	400	8
RV 10SR3/8"WD	400	10
RV 12SR3/8"WD	400	12
RV 14SR1/2"WD	400	14
RV 16SR1/2"WD	400	16
RV 20SR3/4"WD	400	20
RV 25SR1" WD	250	25
RV 30SR1.1/4"WD	250	30
RV 38SR1.1/2"WD	250	38

Terugslagklep met BSP draad en met dichtring

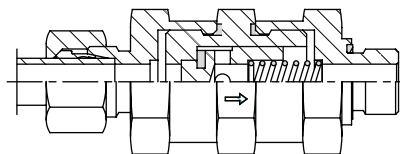

Artikelnummer	PN/WD bar	Pijpmaat mm
Lichte serie		
RZ 06LR1/8"WD	250	6
RZ 08LR1/4"WD	250	8
RZ 10LR1/4"WD	250	10
RZ 12LR3/8"WD	250	12
RZ 15LR1/2"WD	250	15
RZ 18LR1/2"WD	160	18
RZ 22LR3/4"WD	160	22
RZ 28LR1" WD	100	28
RZ 35LR1.1/4"WD	100	35
Zware serie		
RZ 06SR1/4"WD	400	6
RZ 08SR1/4"WD	400	8
RZ 10SR3/8"WD	400	10
RZ 12SR3/8"WD	400	12
RZ 14SR1/2"WD	400	14
RZ 16SR1/2"WD	400	16
RZ 20SR3/4"WD	400	20
RZ 25SR1" WD	250	25
RZ 30SR1.1/4"WD	250	30
RZ 38SR1.1/2"WD	250	38

6

Bordel koppelingen

Bordel koppelingen kunnen gebruikt worden icm
snijringkoppelingen DIN 2353

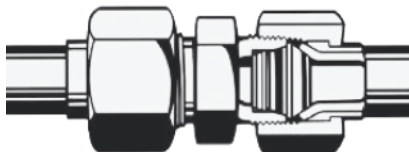

Artikelnummer	Pijpmaat mm
Lichte serie	
6L Flare Set 37°	6
8L Flare Set 37°	8
10L Flare Set 37°	10
12L Flare Set 37°	12
15L Flare Set 37°	15
18L Flare Set 37°	18
22L Flare Set 37°	22
28L Flare Set 37°	28
35L Flare Set 37°	35
42L Flare Set 37°	42
6S Flare Set 37°	6
8S Flare Set 37°	8
10S Flare Set 37°	10
12S Flare Set 37°	12
14S Flare Set 37°	14
16S Flare Set 37°	16
20S Flare Set 37°	20
25S Flare Set 37°	25
30S Flare Set 37°	30
38S Flare Set 37°	38

Deze koppelingen worden als sets geleverd:
Bordel conus / steunhuls / verlengde moer